

I. General

1. GX Pipe and Fittings

Nominal diameter (Pipe size)	75mm (3in.) to 400mm (16in.) (Hereinafter called Size 75 (J3") to 400 (J16"))	
Pipe	Wall thickness class	Class 1 (D1) and Class S (DS)
	Nominal length	Size 75 (J3") and 100 (J4"): 13.12 feet (13' 1-1/2") Size 150 (J6") to 250 (J10"): 16.40 feet (16' 4-7/8") Size 300 (J12") and 400 (J16"): 19.69 feet (19' 8-1/4")
Fittings	Socket Spigot tee with socket branch Socket Spigot reducer, Spigot and socket reducer Socket Spigot bend (90°, 45°, 22-1/2°, 11-1/4°, 5-5/8°) Double Socket bend (45°, 22-1/2°) Socket Spigot tee with flanged branch Socket Spigot tee with flanged branch for shallow buried use (Size 75 (J3") to 250 (J10")) Socket Spigot tee with spiral flanged branch Double Socket Level Invert Tees with Socket Branch (Size 300 (J12") and 400 (J16")) Collar (Mechanical-joint sleeves) Double Socket short pipe Socket Spigot offset (H = 11.8 in. and 17.7 in.) (Size 75 (J3") to 300 (J12")) Cap (Mechanical End Cap)	
Connecting piece for cut pipe	P-Link (for pipe) (Size 75 (J3") to 300 (J12")) G-Link (for fittings) (Size 75 (J3") to 300 (J12"))	

2. GX Joint

(1) Pipe

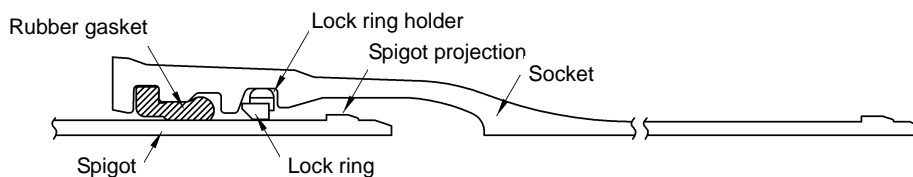

(2) Pipe with Liner

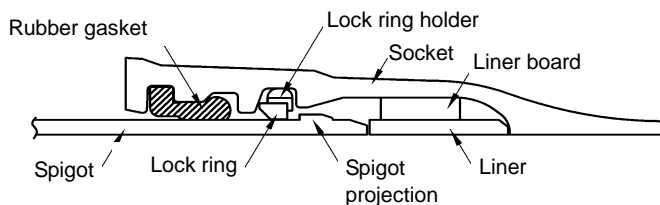

(3) Fittings

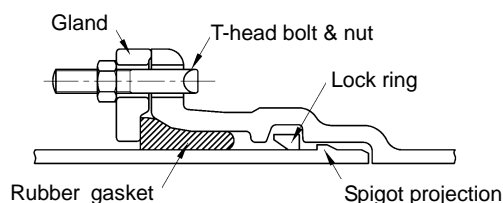

(4) P-Link (Size 75 (J3") to 300 (J12"))

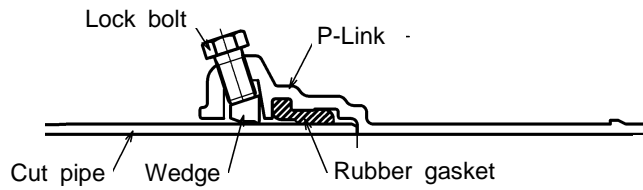

(5) G-Link (Size 75 (J3") to 300 (J12"))

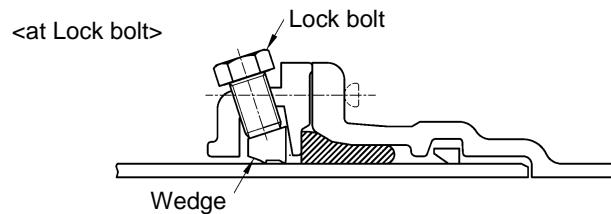
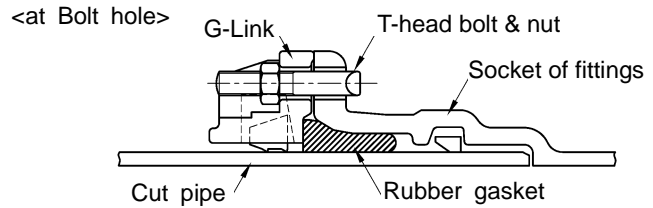
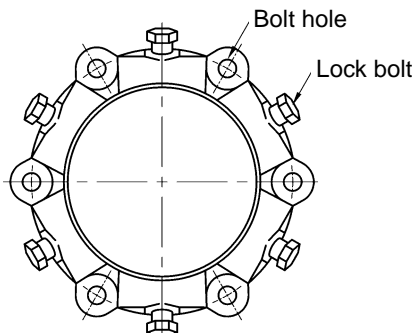

3. Symbol of GX Joint

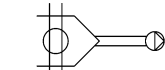
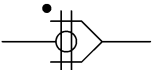
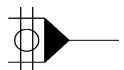
Pipe and fittings	P-Link	G-Link	Pipe with Liner
			

4. Materials of Accessories

Description	Material
Rubber gasket	SBR
Lock ring	Ductile cast iron
Lock ring holder	Polypropylene
Liner	Ductile cast iron
Liner board	Polyamide resin
Gland for fittings	Ductile cast iron
T-bolts & nuts for fittings	Stainless steel
P-Link	Ductile cast iron
G-Link	Ductile cast iron
Lock bolts for P-Link and G-Link	Stainless steel
Wedges for P-Link and G-Link	Ductile cast iron
Stopper for Lock ring of fittings	ABS resin

II. Jointing Procedure

Assemble GX joint strictly in accordance with this manual. To ensure the assembled joint, it is recommended to check the joint conditions with “Joint check sheet”.

1. Assembling of Pipe Joint (factory spigot)

1.1 Cleaning of socket inside and spigot outside

Remove all foreign materials such as sand, mud, gravel, and deposited paint.

1.2 Confirmation of Lock ring

When pipe is delivered, Lock ring and Lock ring holder are attached in the socket. Confirm that they are in the correct position by both visual check and hand (Fig.-1).

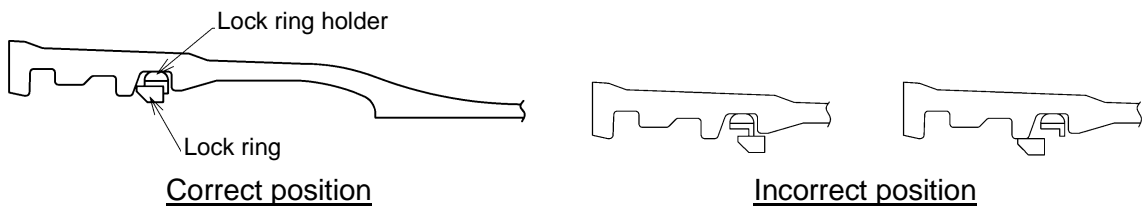

Fig.-1 Position of Lock ring

If Lock ring is not in the correct position, reposition it with special pliers (refer to Annex (1)) and install it again (Fig.-2).

**⚠ Caution:** Do not put fingers between the socket and Lock ring. Fingers may be pinched.

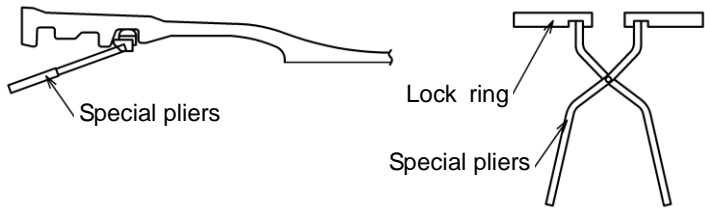

Fig.-2 Repositioning of Lock ring

1.3 Installation of rubber gasket

Confirm that the rubber gasket to be used is for GX pipe (not for fittings or others). Nominal diameter and the letter “GX” are marked on the heel portion of the rubber gasket (Fig.-3).

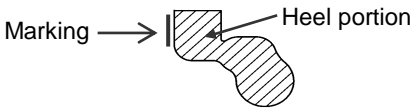

Fig.-3 Marking position of rubber gasket

Clean the rubber gasket, then form it in a heart shape and place in the groove of socket inside ((a) of Fig.-4) so that the heel portion faces the socket end. Press the rubber gasket upward ((b) of Fig.-4), then push the lower portion of the rubber gasket into the groove of socket inside ((c) of Fig.-4).

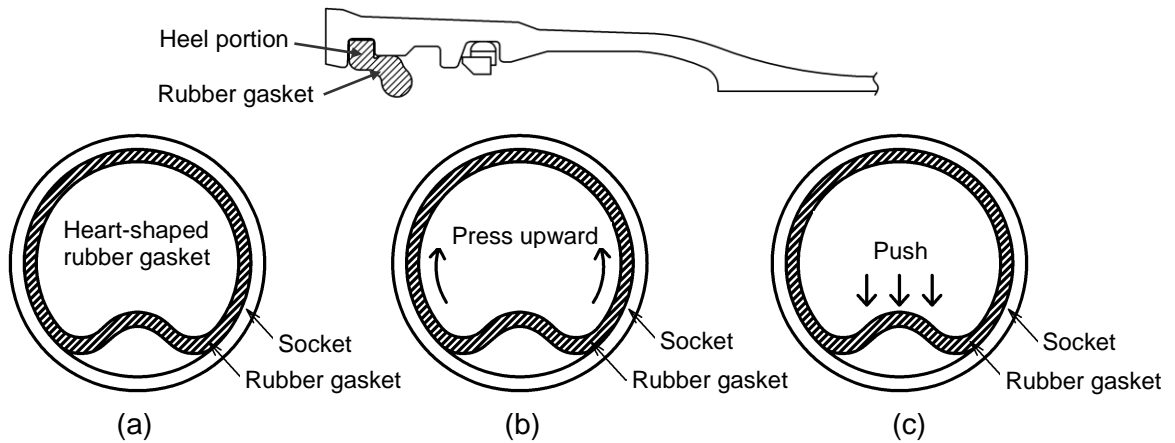

Fig.-4 Installation of rubber gasket

Tamp the rubber gasket lightly with a plastic hammer all around the socket, then confirm by hand that the rubber gasket is seated correctly (Fig.-5).

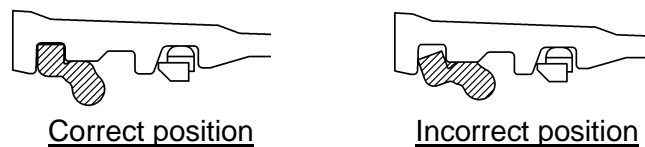

Fig.-5 Position of rubber gasket

#### 1.4 Lubrication

Apply lubricant to the spigot from the spigot end to the white line and also to the rubber gasket (Fig.-6).

Do not apply the lubricant to the socket inside and whole surface of the rubber gasket. This may cause the rubber gasket displacement at pipe jointing work.

Note. Use the lubricant for ductile iron pipe. Never use oil or grease.

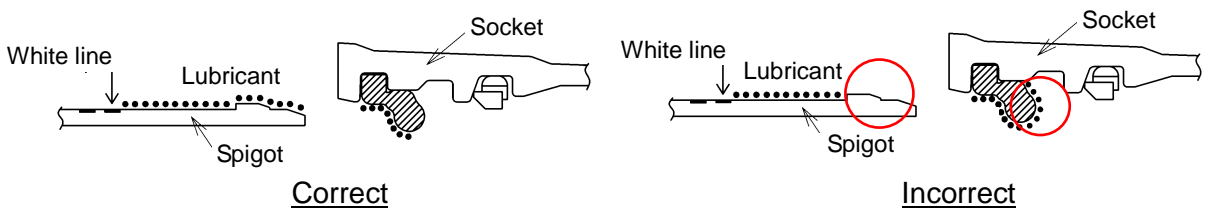

Fig.-6 Application of lubricant

### 1.5 Pipe jointing

#### 1.5.1 Alignment of socket and spigot

Lift the pipe, and then align the spigot and socket. Make sure that deflection of the spigot pipe to the socket pipe does not exceed 2° (see Table-1). Deflection of jointing which exceeds 2°, may cause displacement of the rubber gasket and lock ring.

In the case of pipe with Liner, align the pipes in straight with no deflection.

Table-1 Jointing of pipes with maximum joint deflection

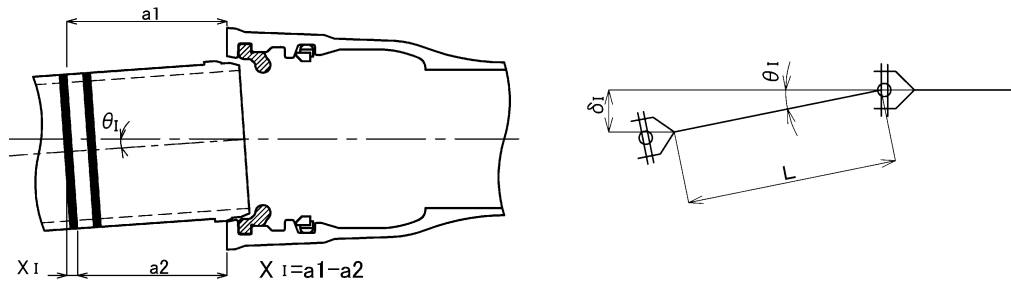

Size	Maximum allowable deflection $\theta_1$ (°)	Maximum difference $X_1 (=a_1 - a_2)$ (in.)	Pipe length L (feet)	Maximum allowable offset $\delta_1$ (in.)
75 (J3")	2	0.12	13.12	5.5
100 (J4")	2	0.16	13.12	5.5
150 (J6")	2	0.24	16.40	6.9
200 (J8")	2	0.31	16.40	6.9
250 (J10")	2	0.35	16.40	6.9
300 (J12")	2	0.43	19.68	8.3
400 (J16")	2	0.59	19.68	8.3

#### 1.5.2 Jointing tools

Place lever hoist and sling belt (refer to Annex (2) and (3)) on the pipes (Photo-1).

Never use the bucket of an excavator to push on the pipe. This may cause displacement of rubber gasket.

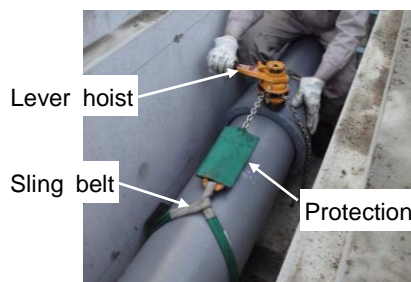

Photo-1 Jointing tools for pipe

To facilitate jointing of short cut pipes or fittings to the socket of pipe, use two lever hoists for the better stability of jointing work.

To protect the external coating of the pipe from getting damaged by the tools, use any protective materials under the lever hoist and sling belt (see Photo-1).

### 1.5.3 Jointing

Pull on the lever hoist until the first white line of the two marked around the spigot comes to the socket end (Fig.-7).

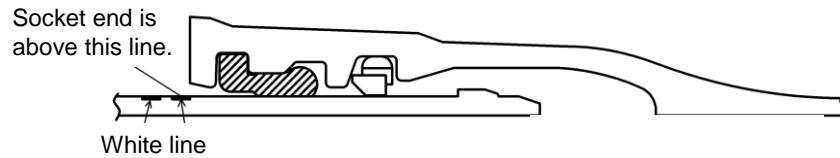

Fig.-7 Completion of pipe jointing

### 1.6 Check of rubber gasket position

Confirm the proper position of the rubber gasket all around the socket by inserting a check gauge (see Annex (4)) to the gap between the socket and spigot.

Measure the insertion depth (b in Table-2) with the 0.08 in. thickness gauge. The value of the insertion depth shall conform to Table-2 to judge that the joint is acceptable.

Use the opposite side of the check gauge (thickness 0.16 in.) if any measurement is out of the allowable value. (This is only applicable for size 75 (J3") thru 250 (J10"), not size 300 (J12") and 400 (J16").) The joint is acceptable if the measurement of the 0.16 in. thickness gauge conforms to Table-2. If not, disassemble the joint and re-assemble the jointing.

Table-2 Allowable insertion depth of check gauge

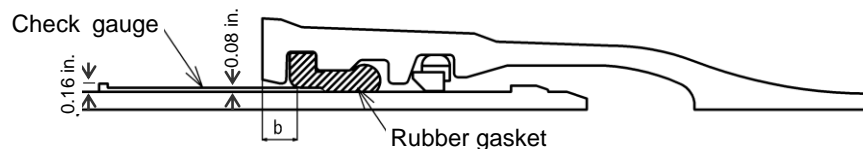

Size	Allowable insertion depth b (mm)
75 (J3") and 100 (J4")	8 to 18
150 (J6") to 250 (J10")	11 to 21
300 (J12")	14 to 24
400 (J16")	14 to 25

When the joint is deflected, the check gauge may not go into the gap. In this case, check the position of the rubber gasket close to the position where the check gauge did not go into the gap.

### 1.7 Installation with joint deflection

The joint can be deflected to the maximum allowable angle (see Table-3) after checking. The deflected angle of the joint can be checked by measuring the distances between the socket end and the white line marked on the spigot at two opposite sides of the pipe or by measuring the offset at the end of the pipe as shown in Table-3.

Table-3 Check of deflection angle

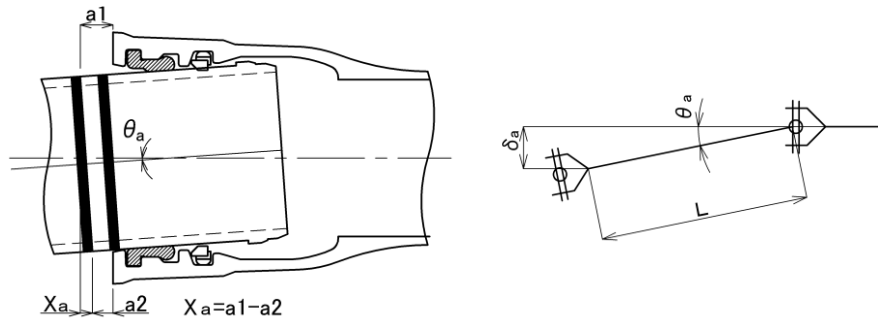

Size	Maximum allowable deflection $\theta_a$ (°)	Maximum difference $X_a (= a1 - a2)$ (in.)	Pipe length L (feet)	Maximum allowable offset $\delta_a$ (in.)
75 (J3")	4	0.24	13.12	11.0
100 (J4")	4	0.31	13.12	11.0
150 (J6")	4	0.47	16.40	13.8
200 (J8")	4	0.59	16.40	13.8
250 (J10")	4	0.75	16.40	13.8
300 (J12")	4	0.90	19.68	16.5
400 (J16")	4	1.18	19.68	16.5

## 2. Assembling of Fitting Joint

### 2.1 Cleaning of socket inside and spigot outside

Remove all foreign materials such as sand, mud, gravel and deposited paint.

### 2.2 Confirmation of Lock ring

When fittings are delivered, Stopper and Lock ring are pre-installed in the socket.

Confirm that they are in the correct position (Fig.-8).

**⚠ Caution:** Do not attempt to pull Stopper unless it is necessary. Lock ring gets released from tension and it may pinch fingers.



Fig.-8 Stopper and Lock ring

If Stopper is dislocated, fix it by expanding Lock ring with Expander (refer to Annex (5)).

**⚠ Caution:** Do not put fingers between the socket and Lock ring. Fingers may be pinched.

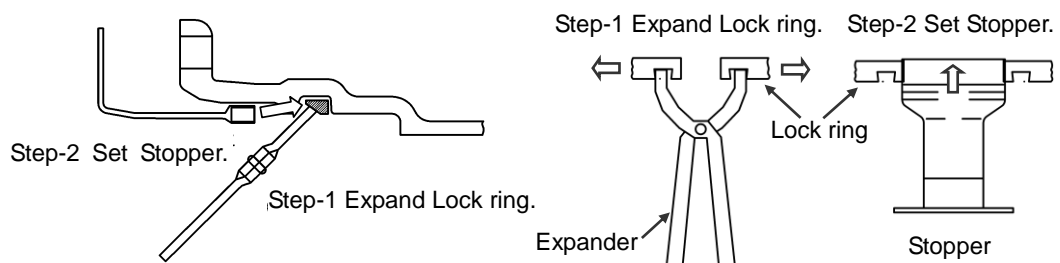

Fig.-9 Reposition of Stopper

### 2.3 Confirmation of socket depth

Measure the socket depth. Copy the measured length on the spigot from its end and mark a circumferential white line or several short lines around the spigot at this length (Fig.-10).

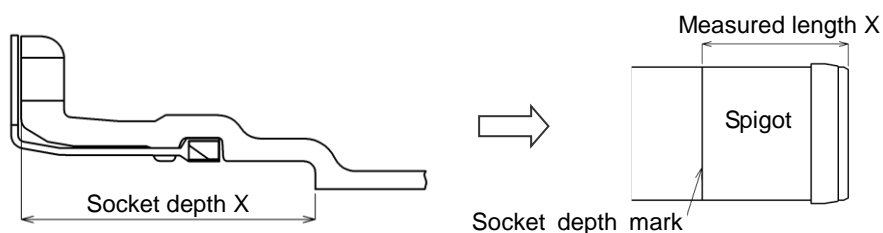

Fig.-10 Marking of socket depth on the spigot



## 2.4 Installation of joint accessories on the spigot

Confirm that the gland and rubber gasket to be used are for GX joint fittings. Nominal diameter and the letter “GX” are marked on the heel of the rubber gasket (Fig.-11).

Note. The shape of the rubber gasket for fittings is different from the gasket for pipe.

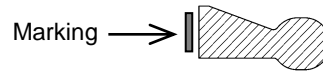

Fig.-11 Marking position of rubber gasket

Clean the gland and rubber gasket then install the gland first and the rubber gasket secondly on the spigot (Fig-12). In this case, confirm that they face correct direction.

Application of lubricant to the inside of the rubber gasket will make its installation easier.

**⚠ Caution:** Handle the gland carefully not to drop on the foot.

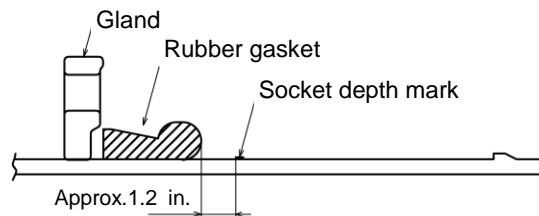

Fig.-12 Installation of gland and rubber gasket

## 2.5 Lubrication

Apply lubricant to the spigot, rubber gasket and socket inside (Fig.-13).

Note. Use the lubricant for ductile iron pipe. Never use oil or grease.

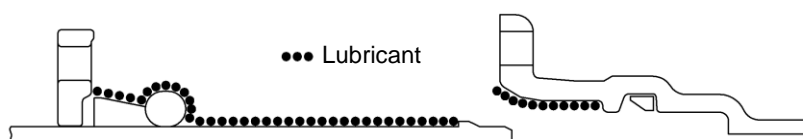

Fig.-13 Application of lubricant

## 2.6 Jointing

### 2.6.1 Alignment of socket and spigot

Lift the pipe or fitting then align the spigot and socket. Insert the spigot into the socket until the spigot end comes to contact with the socket bottom.

After confirmed that the socket end is at the socket depth indication mark ((a) of Fig.-14), pull out Stopper so that Lock ring holds the spigot ((b) of Fig.-14).

If Stopper is displaced before the insertion, reposition Stopper in accordance with 2.2.

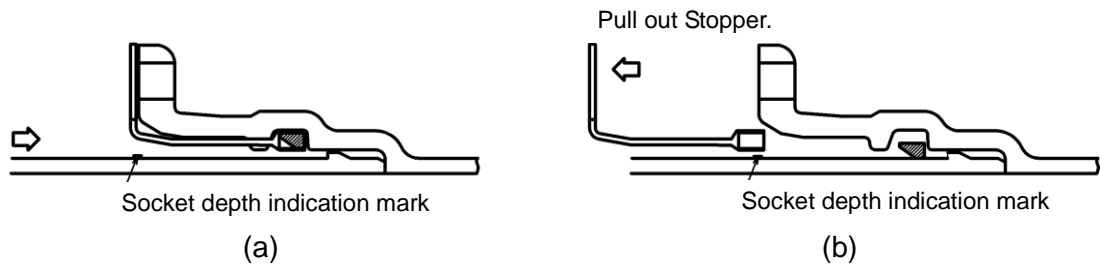

Fig.-14 Insertion of spigot to socket

2.6.2 Confirmation of locked joint

Rock the pipe or fitting vertically and laterally (Fig.-15) while lifting. If the spigot does not come out, the joint is properly locked. If it comes out, reassemble the joint.

**⚠ Caution:** Be careful when rocking the pipe or fitting because it will come out if not locked.

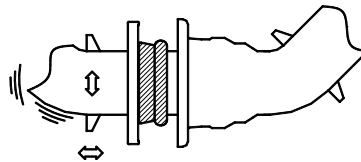

Fig.-15 Confirmation of locked joint

2.6.3 Installation of joint accessories

Push the rubber gasket into the socket. Apply lubricant again if it is dried up. Pull the gland to the socket then align the bolt holes of the gland and socket flange.

Install T-head bolts and nuts to the bolt holes on the gland and socket flange (Fig.-16).

Note. The number of bolt holes on the gland is half of the bolt holes on the socket flange.

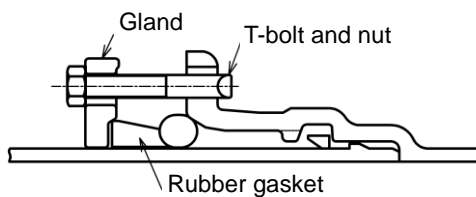

Size	Number of bolt holes		Bolt size (mm)
	Gland	Socket flange	
75 (J3")	2	4	M16
100 (J4")			
150 (J6") & 200 (J8")	3	6	M20
250 (J10") & 300 (J12")	4	8	
400 (J16")	6	12	

Fig.-16 Installation of T-bolt and nut

2.6.4 Bolt tightening

Tighten the bolts and nuts evenly alternating from one side to the other side to make the distance between the gland and socket flange equivalent around the socket.

When the gland comes to contact with the socket flange, the jointing is finished.

Note. As for recommended electric wrench for bolt tightening, refer to Annex (6).

### 2.6.5 Check of assembled joint

Confirm the contact of gland and socket flange at the bolt holes with a 0.02 in. thick gauge (Fig.-17). When checked, the gauge shall not go into the gap between the gland and socket flange.

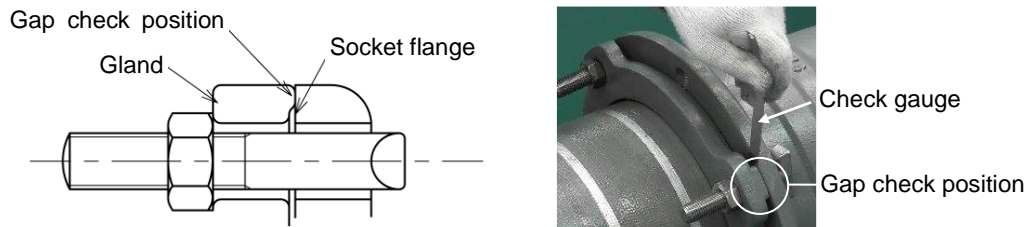

Fig.-17 Check of gap between gland and socket flange

### 3. Assembling of Pipe Joint with Liner

#### 3.1 Installation of Liner board

Install Liner board in the socket so that marked end faces the socket entrance (Fig.-18).

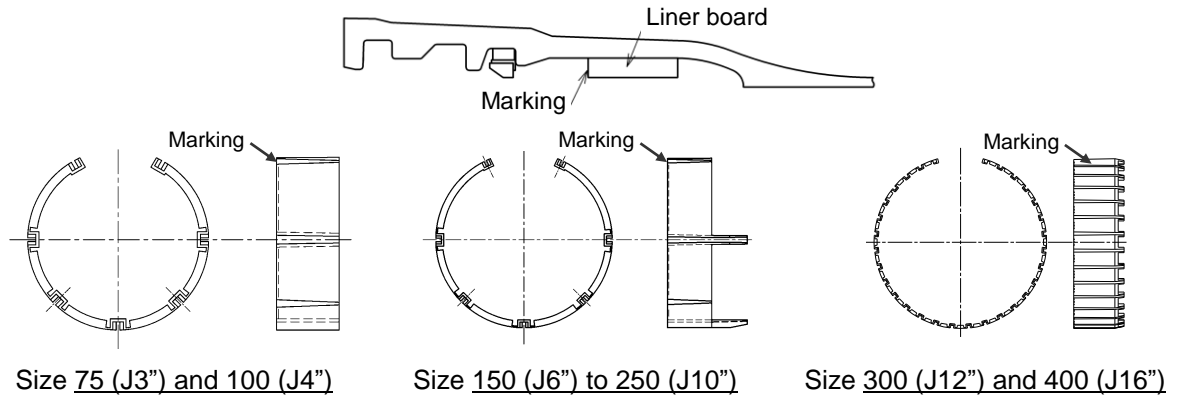

Fig.-18 Liner board

#### 3.2 Installation of Liner

Face the tapered end of Liner and insert Liner until it reaches the socket bottom.

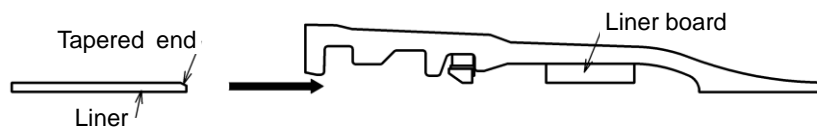

Fig.-19 Installation of Liner

Confirm by hand that Liner surely touches the socket bottom (Fig.-20).

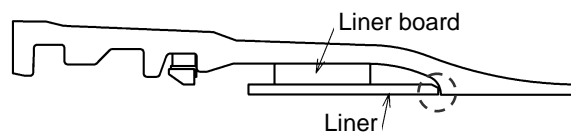

Fig.-20 Correct position of Liner

#### 3.3 Confirmation of Lock ring

Confirm by hand that Lock ring and Lock ring holder are in correct position (see 1.2).

#### 3.4 Confirmation of socket depth

Measure the socket depth (i.e., distance between the socket end and Liner). Copy the measured length on the spigot from its end and mark a circumferential white line or several short lines around the spigot at this length (Fig.-21).

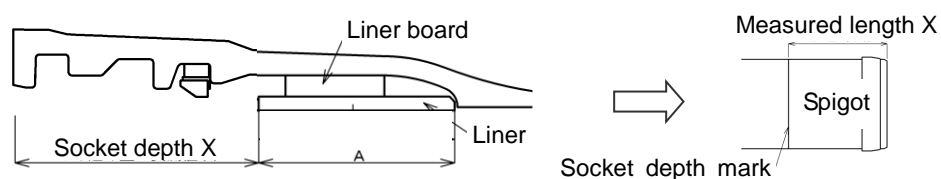

Fig.-21 Marking of socket depth on the spigot

### 3.5 Installation of rubber gasket

Install the rubber gasket in the groove of socket inside then confirm by hand that the rubber gasket is seated correctly (see 1.3).

### 3.6 Lubrication

Apply lubricant to the spigot and rubber gasket (see 1.4).

### 3.7 Pipe jointing

#### 3.7.1 Alignment of socket and spigot

Lift the pipe then align the spigot and socket. Set up the jointing tools to assemble the pipes (see 1.5). In this case, socket and spigot shall be straight with no deflection.

#### 3.7.2 Jointing

Joint the pipes by pulling on the lever hoist. When socket depth mark on the spigot (see Fig.-21) comes to the socket end, the jointing is finished.

#### 3.7.3 Connecting of fittings spigot to pipe socket with Liner

When connecting the spigot of fittings to the socket with Liner, use two lever hoists. In this case, there are two ways to hook the sling belts on the fittings depending on the type of fittings (Fig.-22).

(a) Hook directly on the socket of fittings (Except for bends and offset)

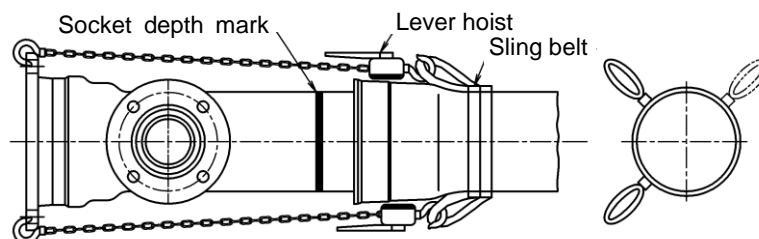

(b) Sling belts around the hooks of fittings (Bends and offset)

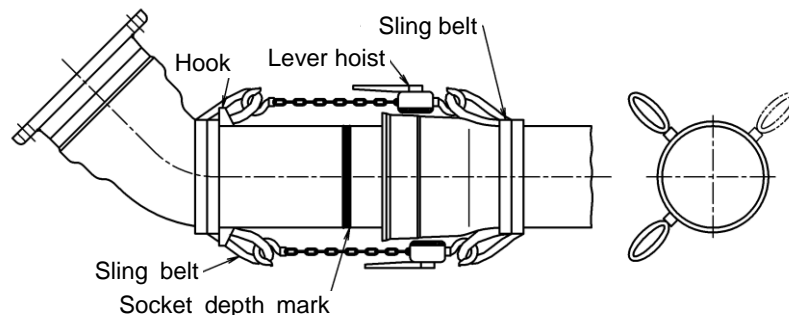

Fig.-22 Position of sling belts for fittings

### 3.8 Check of rubber gasket position

Confirm the proper position of the rubber gasket by check gauge (see 1.6).

#### 4. Assembling of Pipe Joint with Collar

##### 4.1 Connecting two pipes successively with collar

##### 4.1.1 Cleaning of socket inside and spigot outside

Remove all foreign materials such as sand, mud, gravel and deposited paint from the socket inside and spigot outside in about 12 in. from the spigot end.

##### 4.1.2 Installation of gland and rubber gasket

Install the glands and rubber gaskets on the pipes to be connected to the collar.



##### 4.1.3 Confirmation of Lock ring and stopper

Confirm that Lock ring and stopper are in correct position.

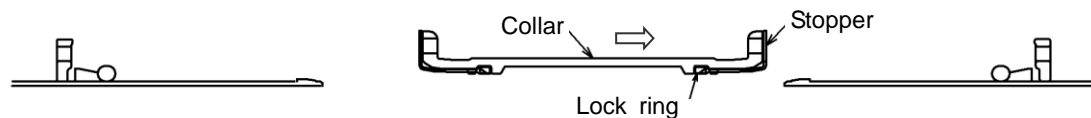

##### 4.1.4 Installation of collar

Install the collar on the previous pipe then pull-out Stopper so that Lock ring holds spigot.



##### 4.1.5 Connection of pipe to collar

Insert the pipe to the collar then pull out Stopper so that Lock ring holds the spigot.

Adjust the distance ( $L'$  in Table-4) between the socket end and white line on the spigot.

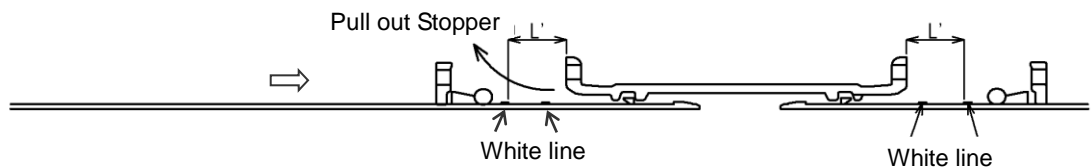

Table-4

Size	$L'$ (in.)
75 (J3")	3.5
100 (J4")	3.7
150 (J6")	4.3
200 (J8") and 250 (J10")	4.7
300 (J12")	5.3
400 (J16")	5.9

##### 4.1.6 Jointing of collar

Assemble the joints of the collar with the same procedure as for fittings. After T-bolts are tightened, confirm that gland touches the socket (Fig.-17).

4.2 Connecting two pipes to tie in with collar

4.2.1 Confirmation of pipe alignment

Confirm that two pipelines are aligned. If not, connect them with two or more collars.

4.2.2 Cleaning of socket inside and spigot outside

Remove all foreign materials such as sand, mud, gravel and deposited paint from the socket inside and spigot outside in about 24 in. from the spigot end.

4.2.3 Installation of gland and rubber gasket

Install the gland and rubber gasket on the spigot of the laid pipe.

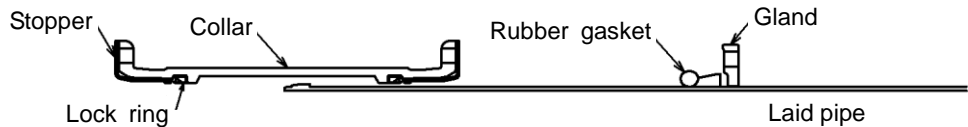

4.2.4 Installation of collar

Install the collar on the laid pipe then pull-out Stopper.



4.2.5 Installation of the opposite side pipe

Install the gland and rubber gasket on the spigot of the opposite side pipe then align the two pipes so that the distance between these pipes is kept in y1 in Table-5.

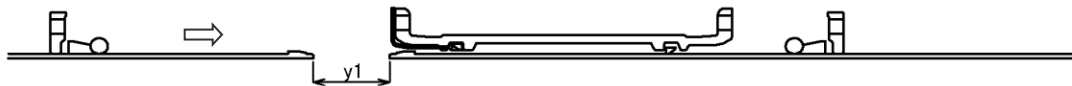

Table-5

Size	y1 (in.)
75 (J3")	7-1/2
100 (J4")	7-7/8
150 (J6")	9-3/8
200 (J8") and 250 (J10")	9-13/16
300 (J12") and 400 (J16")	11-13/16

4.2.6 Shifting of collar

Place the collar in the center of the two pipes then pull-out Stopper.



4.2.7 Jointing of collar

Assemble the joint with the same procedure as fittings. After T-bolts are tightened, confirm that gland touches the socket (Fig.-17).

Remark (1) Joint deflection angle of collar is same as that of pipe.

Remark (2) The spigot of fittings and P-Link must NOT be connected to collar.

Remark (3) Pull out Stopper after the spigot projection passed Lock ring.

Remark (4) When collar is positioned within the required restrained length of pipes for thrust protection of fittings, use G-Link instead of the gland.

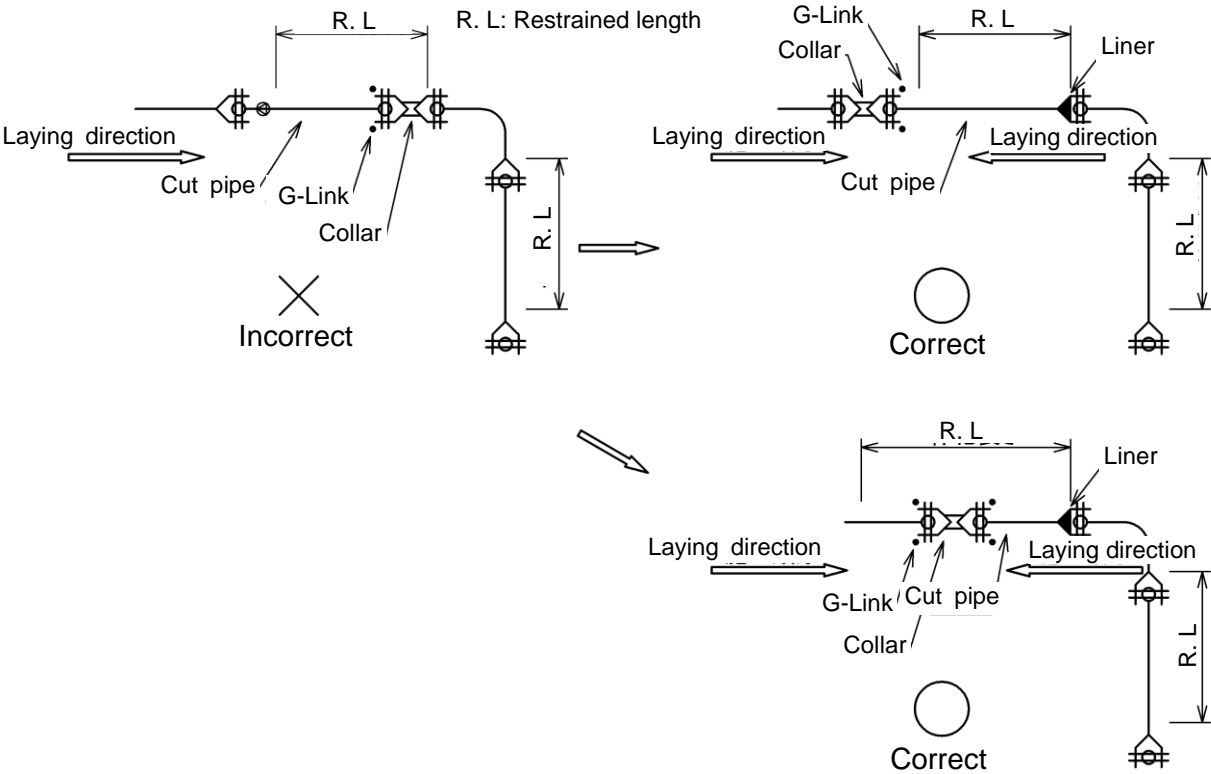

Fig-23 Example of position of collar at bend



## 5. Assembling of Pipe Joint (field cut)

There are three methods to connect the plain spigot of cut pipe to GX socket:

- (1) Using P-Link for the socket of pipe
- (2) Using G-Link for the socket of fittings
- (3) Using spigot projection formed by Spigot ring for the socket of pipe and fittings

### 5.1 Connecting cut pipe to socket of pipe with P-Link

#### 5.1.1 Pipe cutting

- (1) Cut the pipe with suitable equipment.

**⚠ Caution:** When using the cutting machine, follow the manufacturer's instruction.

The length of the cut pipe shall be determined by taking the length of P-Link and amount of expansion by P-Link into consideration as shown in Fig.-24 and Table-6.

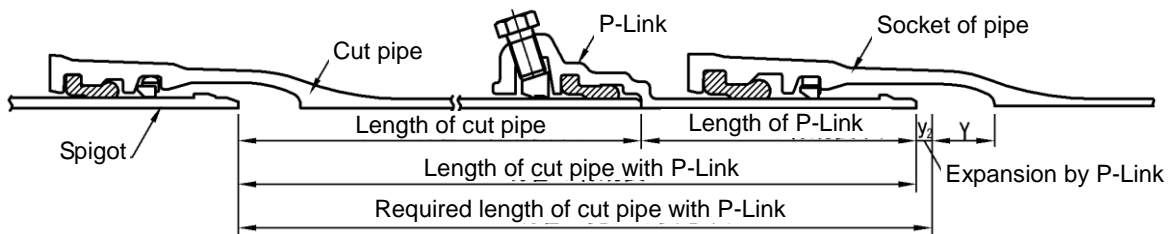

Fig.-24 Length of cut pipe with P-Link

Table-6 Length of P-Link

Size	Length of P-Link (in.)	Expansion by P-Link y2 (in.)
75 (J3")	7-1/8	11/16
100 (J4")	7-1/8	13/16
150 (J6")	8-5/16	15/16
200 (J8")	8-11/16	7/8
250 (J10")	8-11/16	15/16
300 (J12")	10-1/2	13/16

- (2) Chamfer the sharp edges of the cut pipe end with a file or a grinder for the connection to P-Link as shown in Fig.-25.

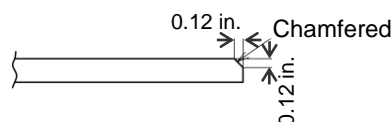

Fig.-25 Chamfer of pipe cut end

After chamfered, apply the repair paint "RP 102" to the cut end of the pipe.

#### 5.1.2 Marking of P-Link insertion depth on spigot

Measure the insertion depth of P-Link (X in Fig.-26). Copy the measured length on the spigot of cut pipe from its end and mark a circumferential white line or several short lines around the spigot at this length as shown in Fig.-26.

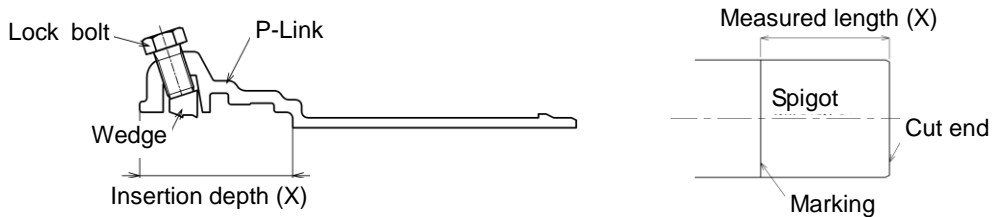

Fig.-26 Marking of P-Link insertion depth on spigot

5.1.3 Connection of P-Link to cut pipe

(1) Confirm that wedges and lock bolts are properly attached (Fig.-27).

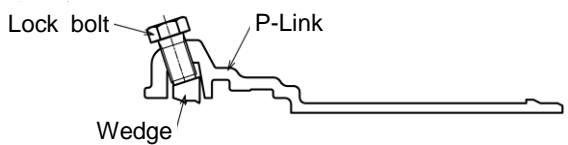

Fig.-27 Wedges and lock bolts of P-Link

Confirm that wedges do not protrude from the groove. If wedges are out of the groove, reset them by alternating Type A and Type B wedges (Fig.-28).

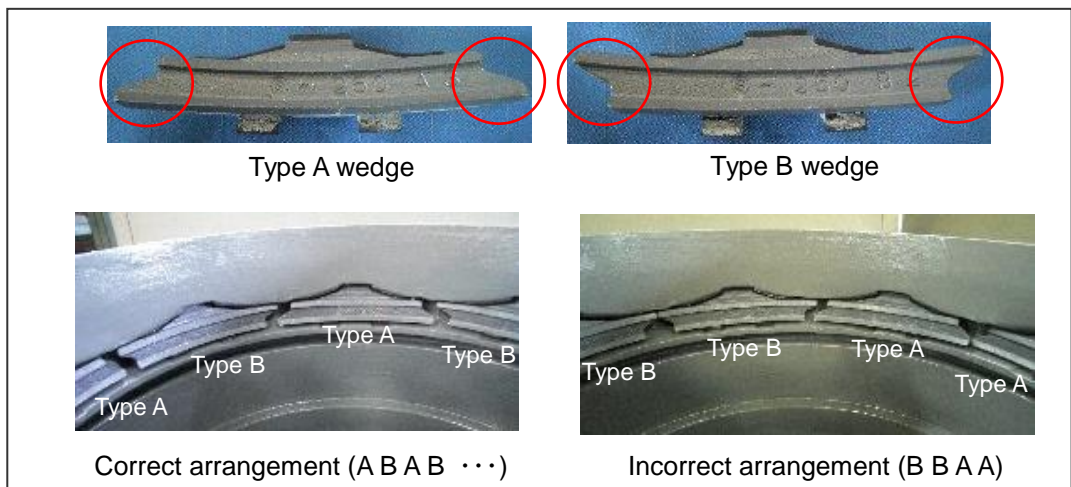

Fig.-28 Arrangement of wedges

(2) Remove all foreign materials such as sand, mud, gravel and deposited paint from the socket inside of P-Link. Then install the rubber gasket (see 1.3) in the socket.

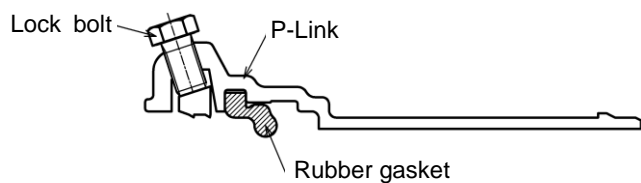

Fig.-29 Installation of rubber gasket

(3) Apply lubricant to the spigot and rubber gasket. Align the pipe and P-Link in straight then assemble them (see 1.5). In this case, use two lever hoists.

When insertion depth mark on the spigot (see 5.1.2) comes to the end of P-Link, the assembly is finished.

(4) Confirm the proper position of the rubber gasket all around P-Link by inserting 0.02 in. thick check gauge to the gap between P-Link and spigot.

When insertion depth conforms to Table-7, the joint is acceptable. If not, measure the insertion depth with 0.08 in. thick check gauge. When insertion depth conforms to Table-7, the joint is acceptable. If not, disassemble the joint and re-assemble the jointing.

Table-7 Allowable insertion depth of check gauge for P-Link

Size	Allowable insertion depth (mm)
75 (J3")	54 to 63
100 (J4") and 150 (J6")	57 to 66
200 (J8") and 250 (J10")	63 to 72
300 (J12")	70 to 80

(5) Tighten all lock bolts by hand until all wedges touch the pipe. Then tighten all lock bolts with the torque wrench (refer to Annex (7)) evenly alternating from one side to the other side with bolting torque 100 N-m (75 ft-lb). An example of bolt tightening order is shown in Fig.-30.

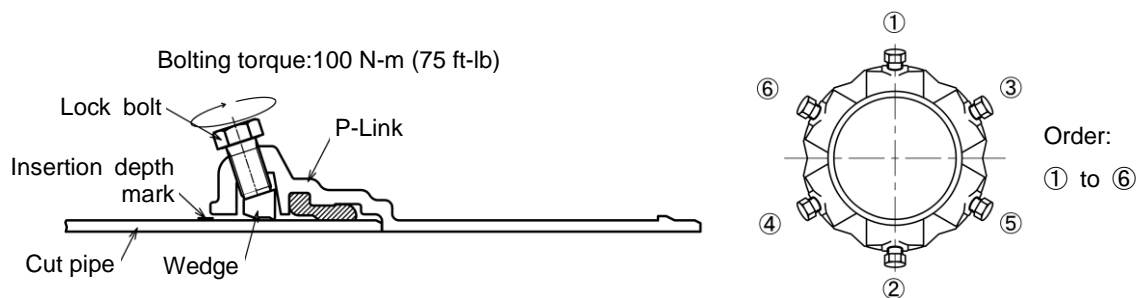

Fig.-30 Lock bolts tightening order (in case of size 6")

#### 5.1.4 Jointing of P-Link and cut pipe with pipe socket

Joint the connected P-Link and cut pipe and pipe with the same manner as the jointing of pipes (see 1.).

However, in this case, jointing is finished when the circumferential line marked on P-Link comes to the socket end (Fig.-31).

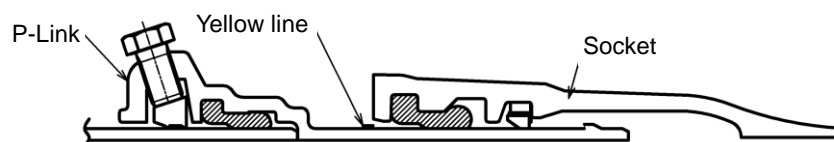

Fig.-31 Jointed P-Link with pipe

## 5.2 Connecting cut pipe to socket of fittings with G-Link

### 5.2.1 Pipe cutting

- (1) Cut the pipe with suitable equipment.

The length of the cut pipe is as shown in Fig.-32.

**⚠ Caution:** When using the cutting machine, follow the manufacturer's instruction.

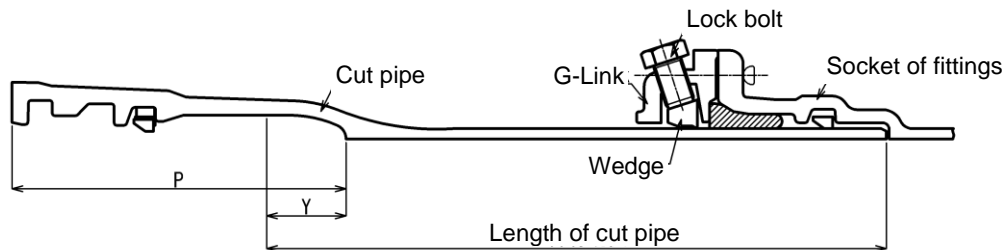

Fig.-32 Length of cut pipe with G-Link

- (2) Chamfer the sharp edges of the cut pipe end with a file or a grinder.  
After chamfered, apply the repair paint "RP 102" to the cut end of the pipe.
- (3) Measure the socket depth of fittings then mark a circumferential white line or several short lines around the spigot for the indication of socket depth (see 2.3).

### 5.2.2 Jointing of cut pipe and fittings with G-Link

- (1) Confirm that wedges and lock bolts are properly attached (Fig.-33).

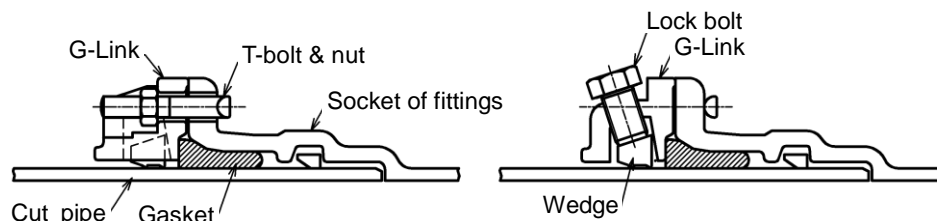

Fig.-33 Wedges and lock bolts of G-Link

Confirm that wedges do not protrude from the groove. If wedges are out of the groove, reset them (see 5.1.3).

- (2) Remove all foreign materials such as sand, mud, gravel and deposited paint.  
Then joint the spigot of cut pipe and socket of fittings with G-Link with the same manner as fittings (see 2.).  
However, in case of G-Link, the number of T-bolts is double of the gland and the confirmation of locked joint by rocking the pipe (see 2.6.2) is unnecessary.
- (3) Tighten all lock bolts by hand until all wedges touch the pipe. Then tighten all lock bolts with the torque wrench evenly alternating from one side to the other side (see 5.1.3 (5)) with bolting torque 100 N-m (75 ft-lb).

5.3 Connecting cut pipe with spigot projection formed by Spigot ring to socket of pipe

5.3.1 Cutting and grooving of pipe

- (1) Cut the pipe then make a groove around the spigot with the Grooving machine (refer to Annex (8)). In this case, Class 1 (marked “D1” on the socket face) pipe shall be cut. Chamfer the spigot end for GX joint. The shape and dimensions of the spigot are given in Table-8.

**⚠ Caution:** When using a cutting or grooving machine, follow the manufacturer’s instruction.

Table-8 Shape and dimensions of the spigot and groove

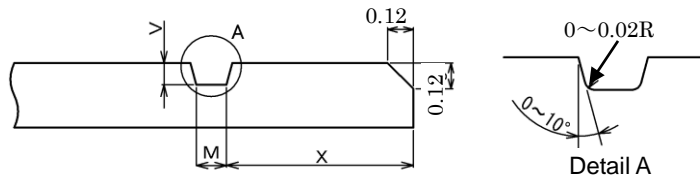

(in.)

Size	M	V	X
75 (J3”) to 250 (J10”)	0.18 +0.04 / 0	0.10 0 / -0.02	0.96 +0.04 / -0.08
300 (J12”) and 400 (J16”)	0.18 +0.04 / 0	0.10 0 / -0.02	0.79 +0.04 / -0.08

- (2) Confirm the shape and dimensions of the groove with the check gauge (see Annex (9)). There shall be no gap between the spigot surface and the gauge when the depth of the groove is checked all around the spigot (Fig-34). If any gap is found, the groove is shallower therefore groove again to the sufficient depth.

The gauge shall not go in the groove when the length from the spigot end is checked (Fig.-35). If the gauge goes in the groove, reject the groove and cut another portion of the pipe.

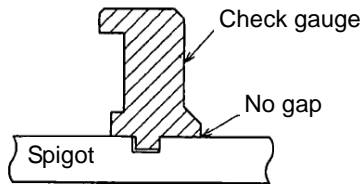

Fig.-34 Check of groove depth

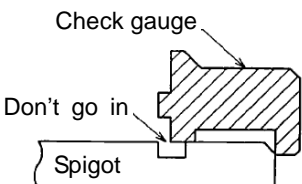
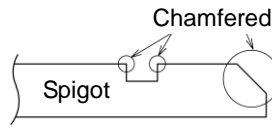

Fig.-35 Check of length from pipe end

- (3) Chamfer the sharp edges of the groove and cut end with a file or a grinder (Fig.-36). For size 300 (J12”) and 400 (J16”) pipe, at the cut end on which the split portion of spigot ring is placed, bevel the cut end carefully as shown in Fig.-36. After chamfering, apply the repair paint “RP 102” to the groove and cut end of the pipe.

At the cut end of size 75 (J3") to 250 (J10") pipe



At the cut end of size 300 (J12") and 400 (J16") pipe

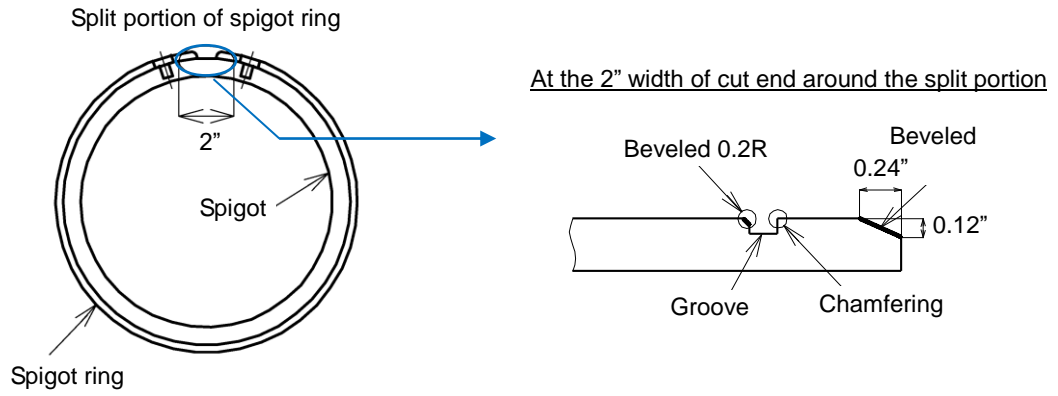

Fig.-36 Chamfering and Beveling

5.3.2 Installation of Spigot ring in the groove

- (1) Confirm that O-ring rubber coheres to the inside of Spigot ring at the guide hole (Fig.-37).  
If not, adhere it with cyanoacrylate adhesive.

Confirm also that seal rubber is attached to Tapping screw (Fig.-38).

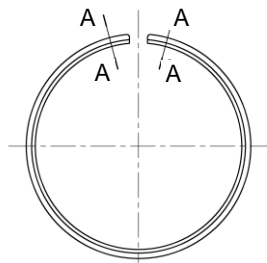

Fig.-37 Spigot ring for cut pipe

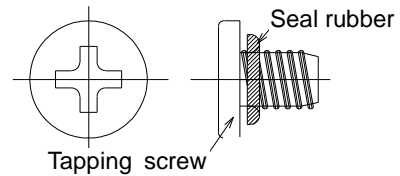
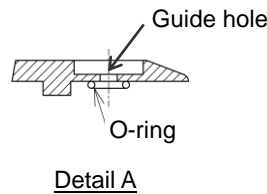
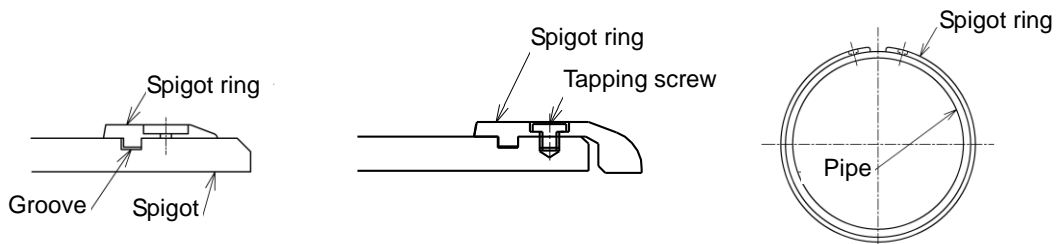

Fig.-38 Tapping screw

- (2) Confirm that there are no foreign materials such as sand in the groove then expand Spigot ring with Expander (refer to Annex (10)) and place it on the spigot (Fig.-39).



Size 75 (J3") to 250 (J10") Size 300 (J12") and 400 (J16")

Fig.-39 Spigot ring set on the spigot end

- (3) Retain the Spigot ring on the spigot with clamps from the bottom to the top (Fig.-40).  
In this case, place the cut portion of Spigot ring on the top.

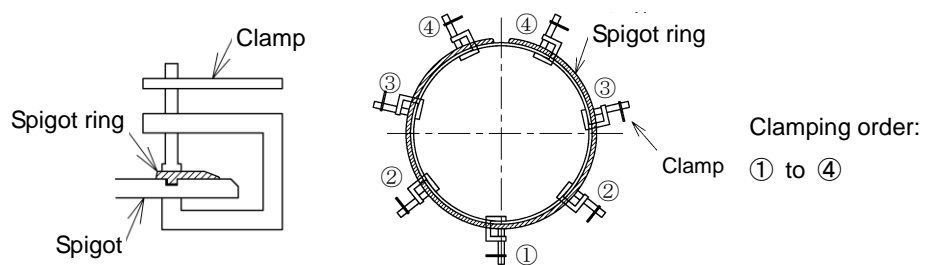

Fig.-40 Retainment of Spigot ring with clamps

- (4) Confirm that 0.02 in. thick gauge does not go into the gap between the spigot and Spigot ring all around the pipe (Fig.-41). If so, remove all clamps and retain Spigot ring again.

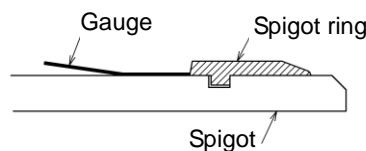

Fig.-41 Check of gap between spigot and Spigot ring

- (5) Drill two holes on the spigot at the guide holes on Spigot ring with a drilling machine (Fig.-42). Use the special drill bit with a stopper to limit the drilling depth to be 0.28 to 0.30 in. (refer to Annex (11)).

After drilled, remove the chips from the drilled holes by brush.

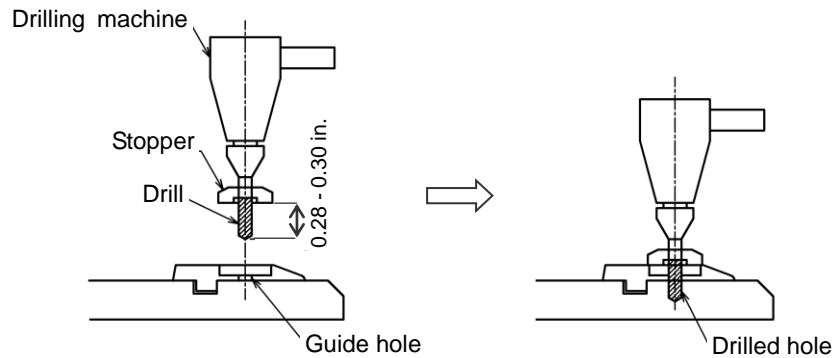
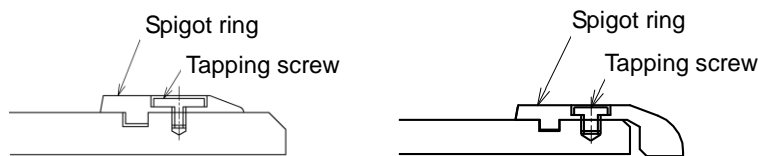

Fig.-42 Drilling

- (6) Install Spigot ring on the spigot by screwing Tapping screw into the drilled holes with a screw driver until its head does not protrude from Spigot ring (Fig.-43). If it cannot be screwed flat, remove Tapping screw and Spigot ring then apply the paint "RP 102" to the drilled holes on the spigot and drill new holes at 90° rotated position around the spigot.



Size 75 (J3") to 250 (J10")    Size 300 (J12") and 400 (J16")



Fig.-43 Spigot ring installed with Tapping screw

When installing Spigot ring on the spigot, follow the below steps.

- i) Use a screw driver suitable for Tapping screw.
  - ii) When Tapping screw is hardly screwed, loosen it once then try to screw again.
  - iii) Fasten Tapping screw carefully to avoid the collapse of the cross on the head. Press and fasten Tapping screw.
  - iv) When using an electric driver, it shall be able to limit the torque to 1.5 to 2 N-m (1.1 to 1.5 ft-lb).
- (7) Remove all clamps then confirm again that 0.02 in. thick gauge does not go into the gap between the spigot and Spigot ring all around the pipe (see Fig.-41). If so, reinstall Spigot ring with the same manner as the method in (6).



5.3.3 Marking of white lines on the spigot

Draw two white lines for jointing on the spigot (Fig.-44).

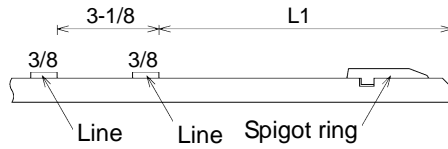

Size 75 (J3") to 250 (J10")

Size	L1 (in.)
75 (J3")	6-5/16
100 (J4")	6-1/2
150 (J6")	7-5/16
200 (J8") and 250 (J10")	7-11/16
300 (J12")	8-7/8
400 (J16")	9-3/8

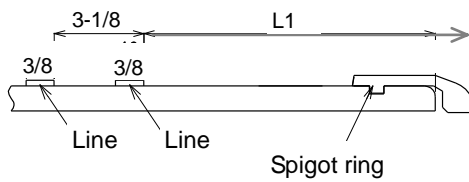

Size 300 (J12") and 400 (J16")

Fig.-44 White lines for jointing

6. Disassembling of Joint

6.1 Pipes

(1) Align the pipes in straight. Disassembling with deflected joint is difficult.

(2) Mark the insertion depth (see Table-9) on the wedge plates (refer to Annex (12)).

Table-9 Insertion depth of wedge plate

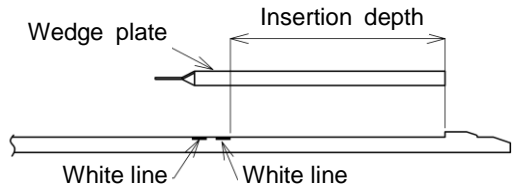

Size	Insertion depth (in.)	
	For pipe	For P-Link
75 (J3")	5	3-7/8
100 (J4")	5-3/16	4-3/8
150 (J6")	6	5-1/8
200 (J8") and 250 (J10")	6-3/8	5-1/2
300 (J12")	7-1/2	6-11/16
400 (J16")	8-1/8	-

Apply lubricant to the wedge plates then push them into the gap between the socket and spigot. In this case, the tapered end is placed upward, not upside down (Fig.-45).

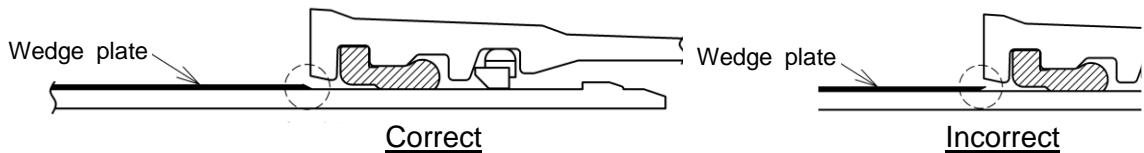

Fig.-45 Tapered end of wedge plate

Hammer the wedge plates with the cap (refer to Annex (12)) until they touch the spigot projection (Fig.-46). When the mark on the wedge plate comes to the white line on the spigot, the wedge plate properly reaches the spigot projection.

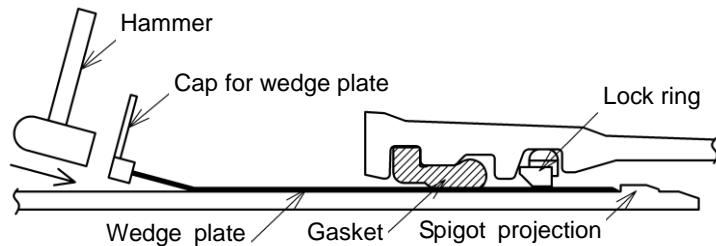

Fig.-46 Pushed wedge plate into socket

Note. Inadequate or excessive insertion of the wedge plate will keep the joint from disassembling (Fig.-47).

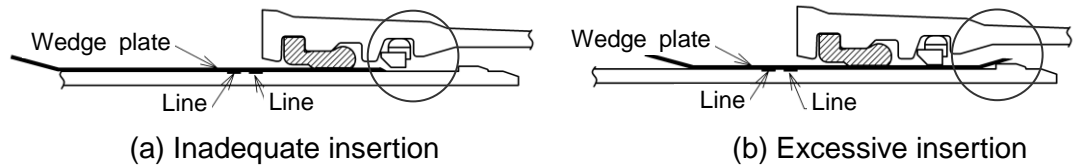

Fig.-47 Improper insertion of wedge plate

Repeat the same process at 8 to 12 positions with even pitches around the socket.

Note. When the joint is locked (see Fig.-48), push the spigot into the socket a little.

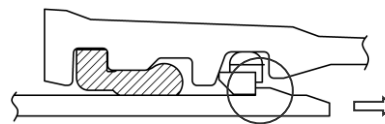

Fig.-48 Locked joint

- (3) Place a split retainer gland (refer to Annex (13)) on the spigot. Place two hydraulic jacks between the split retainer gland and socket end on each side of the pipe (see Fig-49). Then operate the hydraulic jacks and disassemble the joint.

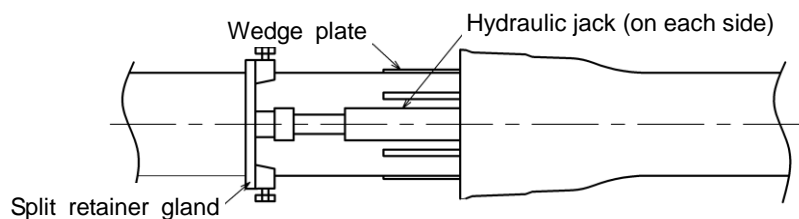

Fig.-49 Layout of disassembling tools

## 6.2 Fittings

- (1) Loosen and remove all T-head bolts and nuts then pull back the gland. Pull out the rubber gasket from the socket with a suitable tool such as a screw driver.
- (2) Apply lubricant to the 0.12 in. thick wedge plate for fittings (refer to Annex (12)). Push the wedge plates into the gap between the socket and spigot through the gland and rubber gasket then hammer it until it reaches the spigot projection (Fig.-50). Repeat the same process at 8 to 12 positions with even pitches around the socket.

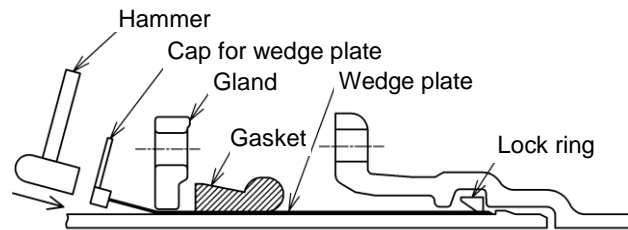

Fig.-50 Wedge plate into socket

(3) Rock the pipe and pull it out slowly.

### 6.3 P-Link

(1) Loosen all Lock bolts sufficiently.

(2) Place the 0.04 in. thick thin plate (refer to Annex (14)) into the gap between the wedge of P-Link and spigot at the lock bolt then hammer it to lift the wedge (Fig.-51).

Repeat the same process at all lock bolts.

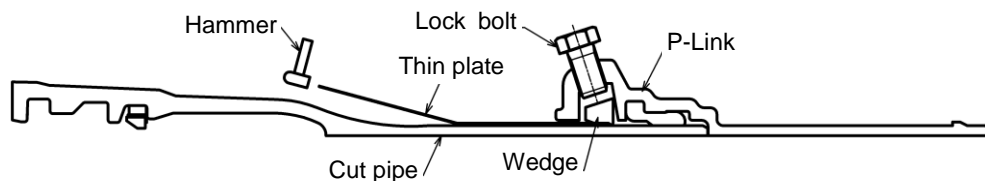

Fig.-51 Placing thin plate into P-Link

(3) Rock the pipe and pull it out slowly. As for the pipe connected to P-Link, disassemble it in accordance with 6.1.

### 6.4 G-Link

(1) Loosen all lock bolts sufficiently.

(2) Place the 0.04 in. thick thin plate (refer to Annex (14)) into the gap between the wedge of G-Link and spigot under the lock bolt then hammer it to lift the wedge (Fig.-52).

Repeat the same process at all lock bolts.

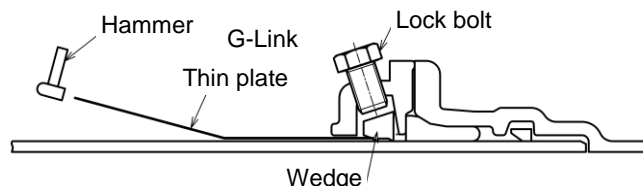

Fig.-52 Placing thin plate into G-Link

(3) Loosen and remove all T-bolts and nuts then pull back G-Link. Pull out the rubber gasket from the socket with a suitable tool such as a screw driver.

(4) Rock the cut pipe and pull it out slowly.

Annex I - Special Tools for GX Joint Assembling/Disassembling and Pipe Cutting

Description	Quantity	Remark
<b>1. For joint assembling</b>		
(1) Special pliers for Lock ring	1	
(2) Lever hoist [5 kN (1100 lbf), 8 kN (1800 lbf)]	2 each	
Lever hoist [20 kN (4500 lbf)]	2 each	
(3) Sling belt [For size 75 (J3") to 250 (J10")]	4	for pipe and P-Link
Round sling [For size 300 (J12") and 400 (16")]	4	for pipe and P-Link
(4) Check gauge for rubber gasket	1	for pipe
(5) Lock ring expander	1	for fittings
(6) Electric impact wrench with universal joint and long socket (M16mm, M20mm)	1	
(7) Torque wrench [M20mm, 100 N-m (75 ft-lb)]	1	for P-Link and G-Link
<b>2. For providing spigot projection to cut pipe</b>		
(8) Electric grooving machine with spacer and guide ring	1	Can be used as cutting machine
(9) Groove check gauge	1	
(10) Spigot ring expander	1	
(11) Drilling machine and drill with stopper	1	Drill with stopper
<b>3. For joint disassembling</b>		
(12) Wedge plate (0.12 in. thick and 12in. long for pipe and 7-1/2 in. long for fittings)	12 each	
Cap for wedge plate	1	Useable for both pipe and fittings
(13) Split retainer gland	1	for pipe and P-Link
(14) Thin plate (0.04 in. thickness)	2	for P-Link and G-Link

(1) Special pliers for Lock ring



(2) Lever hoist



Size	Capacity
75 (J3") and 100 (J4")	5 kN (1100 lbf)
150 (J6") to 250 (J10")	8 kN (1800 lbf)
300 (J12") and 400 (J16")	20 kN (4500 lbf)

(3) Sling belt and Round sling

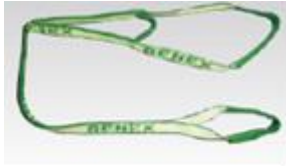

Sling belt for size 75 (J3") to 250 (J10")



Round sling for size 300 (J12") and 400 (J16")

(4) Check gauge for rubber gasket

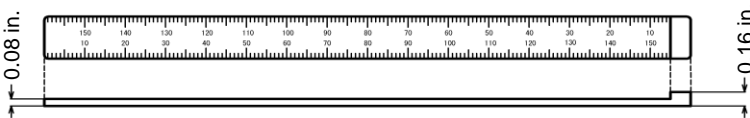

Material: Plastic

(5) Lock ring Expander for fittings



(6) Electric impact wrench for fittings



Size	Connector Sq. (mm)	Torque Max. (N-m)
75 (J3")	12	150 (110 ft-lb)
100 (J4") to 400 (J16")	16	350 (260 ft-lb)

(7) Torque wrench for P-Link and G-Link [M20mm, 100 N-m (75 ft-lb)]



(8) Electric grooving machine and guide ring

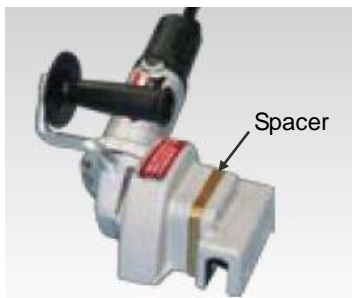

Guide ring

(9) Groove check gauge for cut pipe



(10) Spigot ring expander for cut pipe



(11) Drilling machine



Drill with stopper

(12) Wedge plate and Cap for disassembling of joint



(a) For pipe (L = 12 in.)



(b) For fittings (L = 7-1/2 in.)



(c) Cap for wedge plate

(13) Split retainer gland



(14) Thin plate for disassembling of P-Link and G-Link



Annex II - Technical data for the design of GX type pipeline

Table-A1 Calculation method for the decision of cut pipe length

Combination of joints	Whole length of cut pipe	Simplified formula		
		Size	L (in.)	
	$L = L_m + P - Y$	75 (J3")	$L = L_m +$ 6-5/16	
		100 (J4")		6-1/2
		150 (J6")		7-5/16
		200 (J8")		7-11/16
		250 (J10")		7-11/16
		300 (J12")		8-7/8
		400 (J16")		9-1/2
	$L = L_e + P - Y$ $= L_m + P - Y - y_1$	75 (J3")	$L = L_m -$ 1-3/16	
		100 (J4")		1-3/8
		150 (J6")		2-1/8
		200 (J8")		2-3/16
		250 (J10")		2-1/8
		300 (J12")		2-7/8
		400 (J16")		2-5/16
	$L = L_e$ $= L_m - 2y_1$	75 (J3")	$L = L_m -$ 15	
		100 (J4")		15-11/16
		150 (J6")		18-7/8
		200 (J8")		19-11/16
		250 (J10")		19-11/16
		300 (J12")		23-5/8
		400 (J16")		23-5/8
	$L = L_e$ $= L_m - y_1 - A$	75 (J3")	$L = L_m -$ 10-3/8	
		100 (J4")		10-13/16
		150 (J6")		13-5/16
		200 (J8")		13-11/16
		250 (J10")		13-11/16
		300 (J12")		16-13/16
		400 (J16")		16-7/8
	$L = L_e + P - Y - L_p$ $= L_m + (P - Y) - (L_p + Y + y_2)$	75 (J3")	$L = L_m -$ 3-3/16	
		100 (J4")		3-1/8
		150 (J6")		4-3/16
		200 (J8")		4-3/16
		250 (J10")		4-5/8
		300 (J12")		5-3/16
		-		-



Table-A1 Calculation method for the decision of cut pipe length (continued)

Combination of joints	Whole length of cut pipe	Simplified formula	
		Size	L (in.)
	$L = Le + P - Y - Lp$ $= Lm + (P - Y) - (Lp + A)$	75 (J3")	3-11/16
		100 (J4")	3-1/2
		150 (J6")	4-13/16
		200 (J8")	4-7/8
		250 (J10")	5-3/16
		300 (J12")	6-5/8
		-	-
	$L = Le - Lp$ $= Lm - y1 - (Lp + Y + y2)$	75 (J3")	17
		100 (J4")	17-1/2
		150 (J6")	21
		200 (J8")	21-11/16
		250 (J10")	22-3/16
		300 (J12")	25-7/8
		-	-

L: Whole length of cut pipe from the socket/spigot end to the spigot end

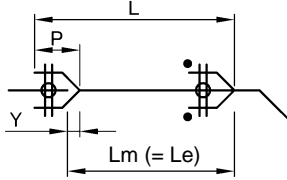
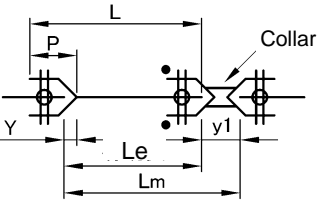
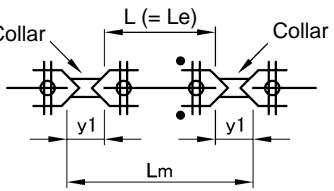
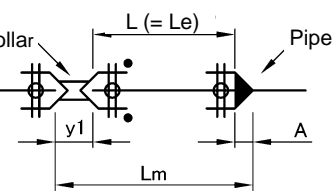
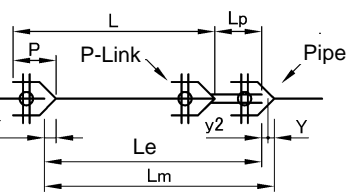
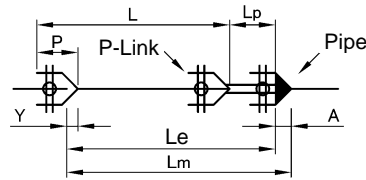
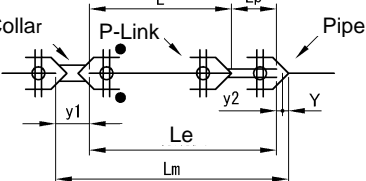
Lm: Empty length to be filled with cut pipe

Le: Effective length (i.e., actual length of the pipe barrel plus Y)